

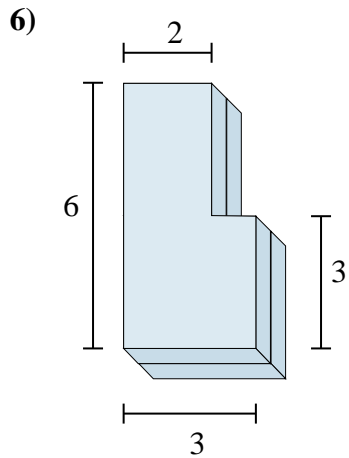

Find the total volume of each figure shown. Measured in cm (not to scale).

Answers

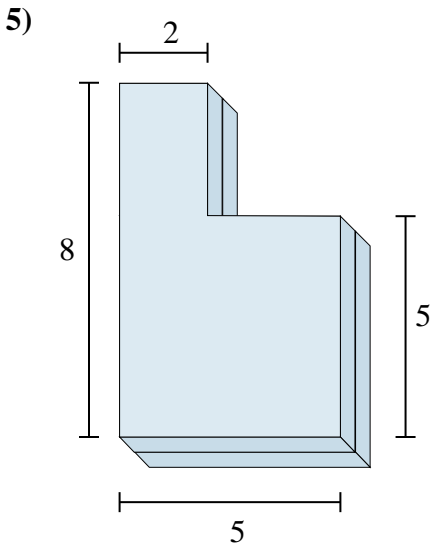
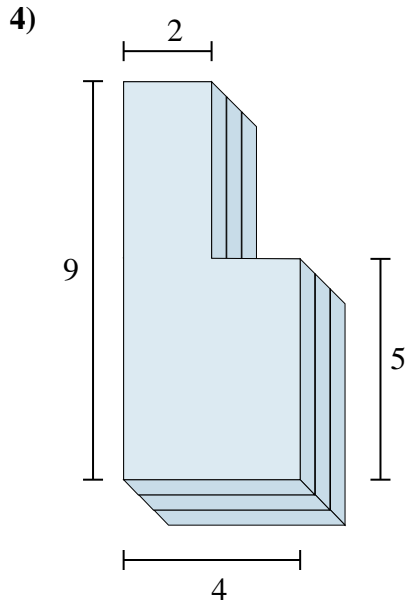
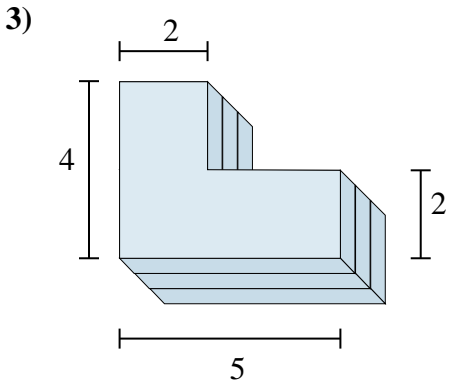
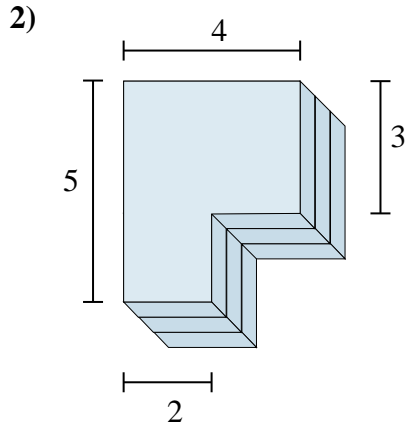
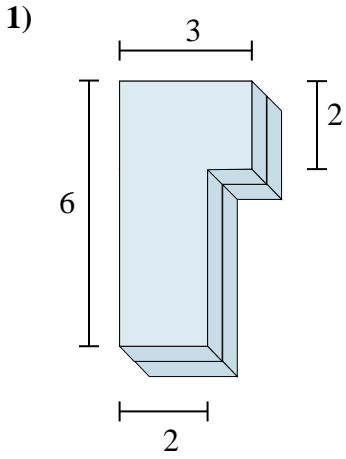

1. _____
2. _____
3. _____
4. _____
5. _____
6. _____



Find the total volume of each figure shown. Measured in cm (not to scale).

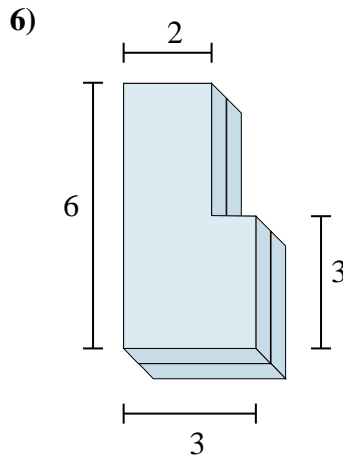
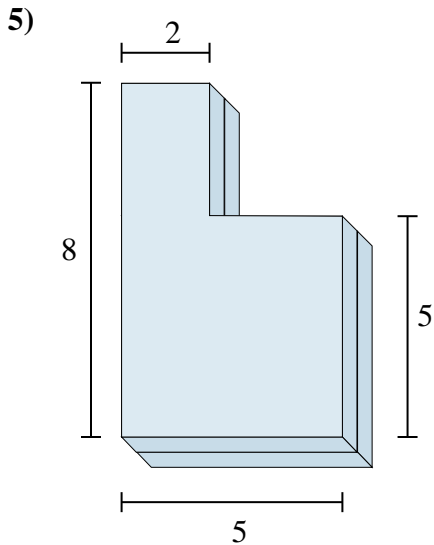
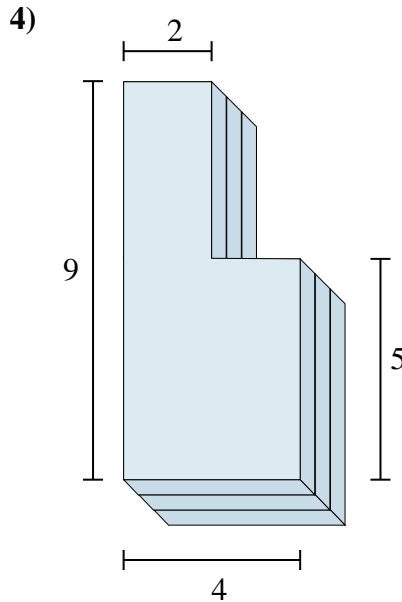
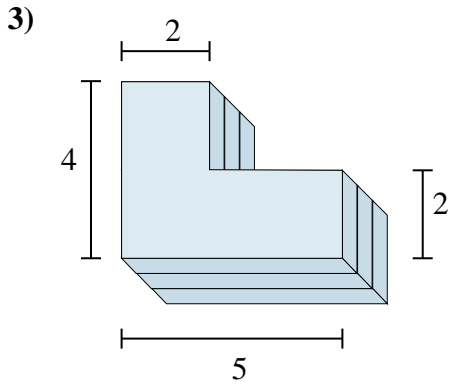
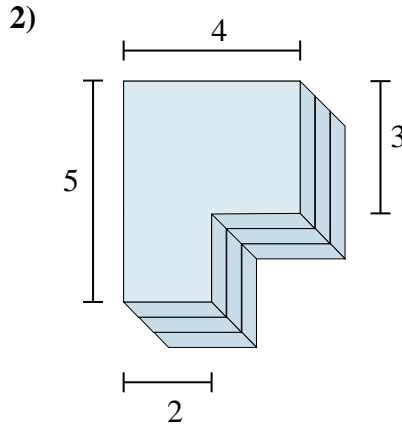
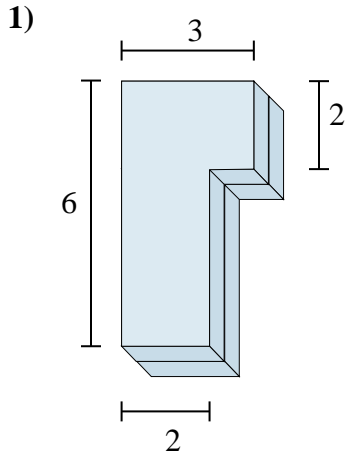

Answers

1. **28 cm³**

2. **48 cm³**

3. **42 cm³**

4. **84 cm³**

5. **62 cm³**

6. **30 cm³**



Find the total volume of each figure shown. Measured in cm (not to scale).

Answers

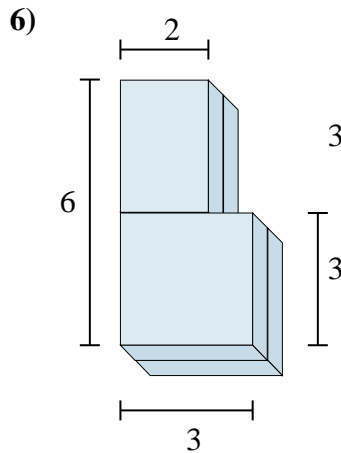
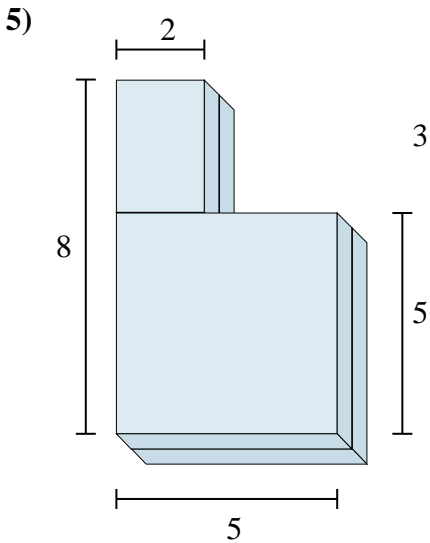
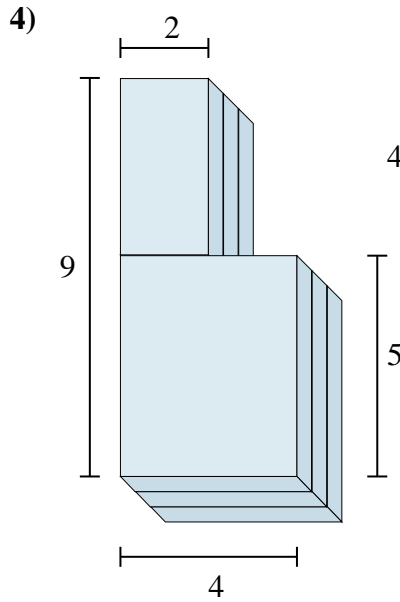
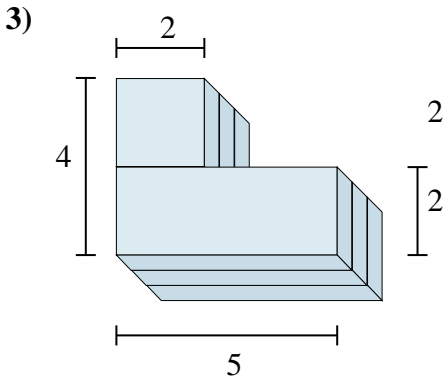
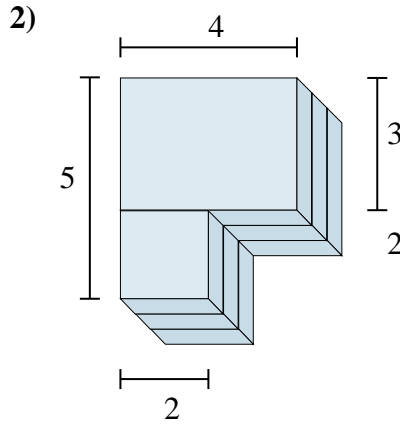
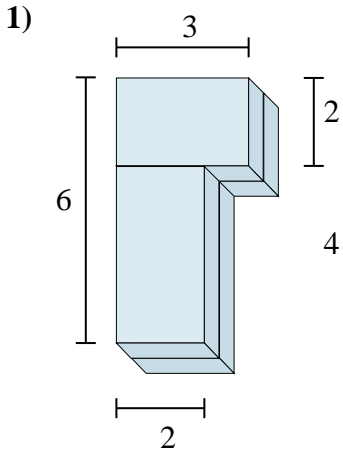

1. _____
2. _____
3. _____
4. _____
5. _____
6. _____